

Data Sheet

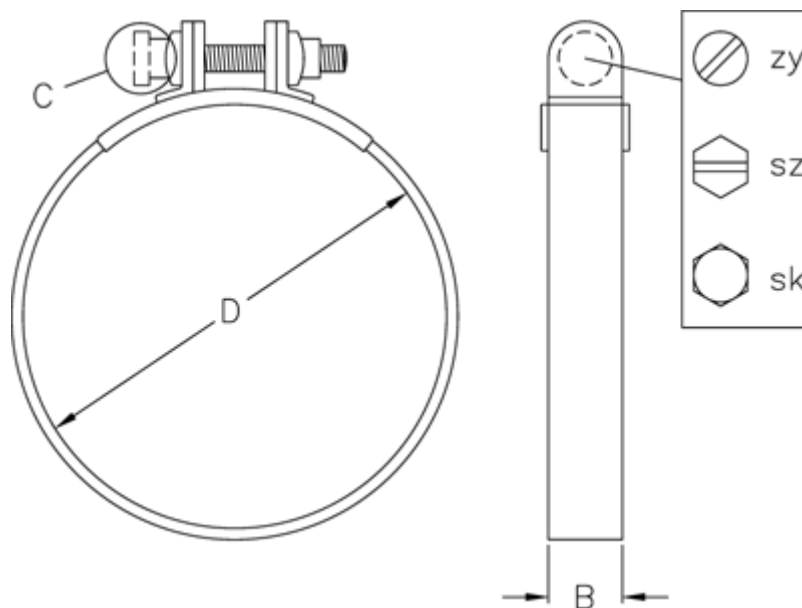

Article number: 02150000040
Description: Sealing Clamp S 40 W1

Measures



C (screw type) = SZ
Diameter D = 40
Width B = 20